

NOTE:  
 1 - DIMENSIONS SHOWN IN [mm]/INCHES.  
 2 - DIMENSIONS SUBJECT TO CHANGE WITHOUT NOTICE.  
 3 - SEE INDIVIDUAL COMPONENTS CUD FOR MORE INFORMATION.

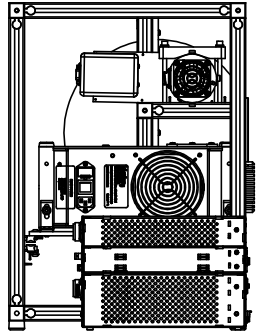

2 EA MC-1000 MOTOR CONTROLLER

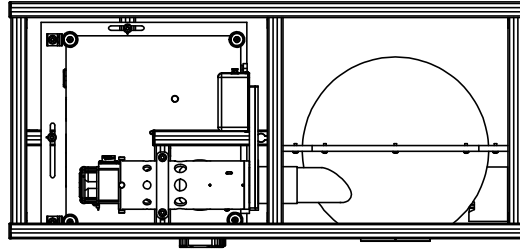
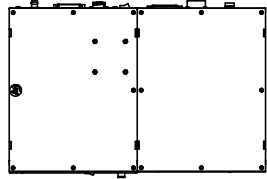
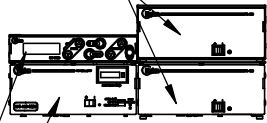

SC 6000 SYSTEM CONTROLLER

LPS-150-0625 PRESET POWER SUPPLY

175W XENON SOURCE WITH VARIABLE ATTENUATOR

EHLS-200-150 TUNGSTEN HALOGEN SOURCE WITH VARIABLE ATTENUATOR

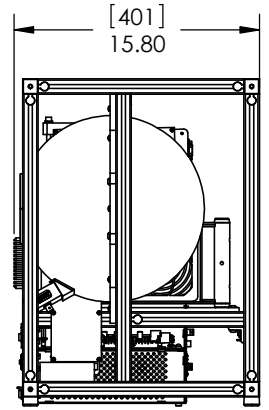
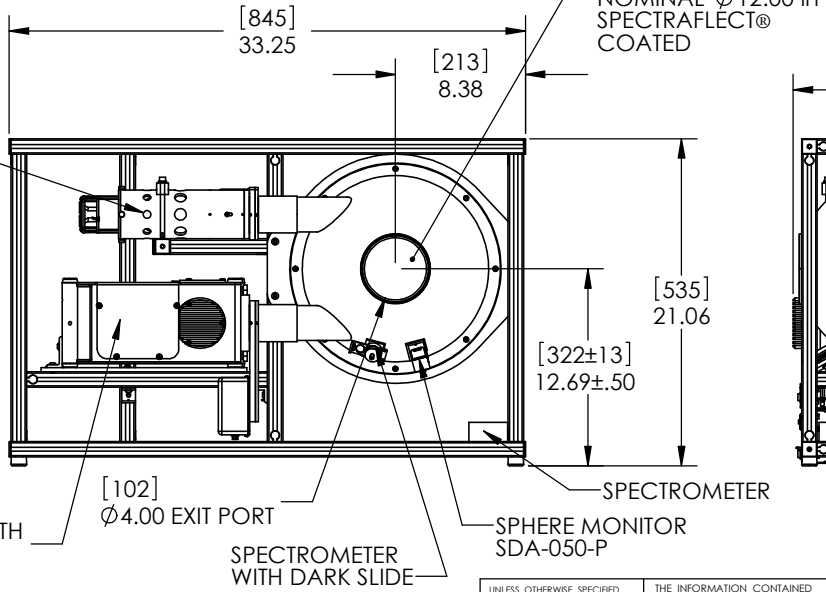

UNLESS OTHERWISE SPECIFIED DIMENSIONS ARE IN INCHES TOLERANCES ARE:  
 FRACTIONS DECIMALS ANGLES  
 $\pm 1/64$  .XX =  $\pm 0.03$   $\pm 30'$   
 XXX =  $\pm 0.015$

CAD GENERATED DRAWING. DO NOT MANUALLY UPDATE MATERIAL

THE INFORMATION CONTAINED IN THIS DRAWING IS THE SOLE PROPERTY OF labsphere, INC. ANY REPRODUCTION IN PART OR IN WHOLE WITHOUT THE WRITTEN PERMISSION OF labsphere, INC. IS PROHIBITED

**labsphere** PO BOX 70  
 231 SHAKER STREET  
 NORTH SUTTON, NH  
 03260

XTH-1200C

FINISH  
 RESP ENG  
 L. BROWN  
 DO NOT SCALE DRAWING

APPROVALS  
 DATE  
 2/26/2007  
 CHECKED/APPRVD

SIZE B SCALE 1:8 SHEET 1 OF 1  
 DWG. NO. AA-00900-000 CUD REV.

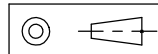

NOTE:  
 1 - DIMENSIONS SHOWN IN [mm]/INCHES.  
 2 - DIMENSIONS SUBJECT TO CHANGE WITHOUT NOTICE.  
 3 - SEE INDIVIDUAL COMPONENTS CUD FOR MORE INFORMATION.

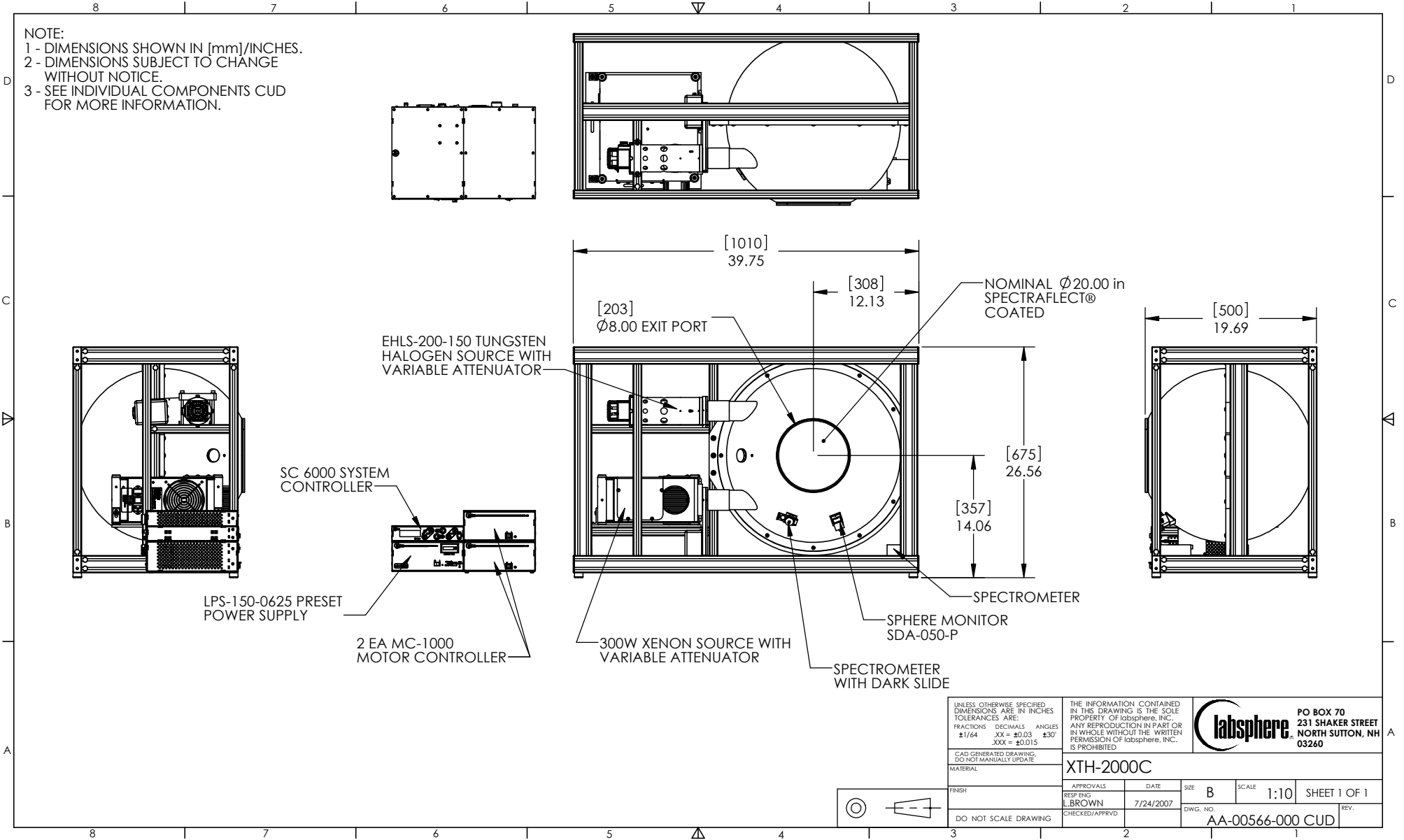

UNLESS OTHERWISE SPECIFIED  
 DIMENSIONS ARE IN INCHES  
 TOLERANCES ARE:  
 FRACTIONS DECIMALS ANGLES  
 ±1/64 .01 .030 ±30°  
 .001 = ±0.015

THE INFORMATION CONTAINED  
 IN THIS DRAWING IS THE SOLE  
 PROPERTY OF labsphere, INC.  
 ANY REPRODUCTION IN PART OR  
 IN WHOLE WITHOUT THE WRITTEN  
 PERMISSION OF labsphere, INC.  
 IS PROHIBITED

**labsphere** PO BOX 70  
 231 SHAKER STREET  
 NORTH SUTTON, NH  
 03260

CAD GENERATED DRAWING. DO NOT MANUALLY UPDATE		MATERIAL		XTH-2000C	
APPROVALS	DATE	SIZE	SCALE	SHEET 1 OF 1	
RESP ENG L.BROWN	7/24/2007	B	1:10		
DO NOT SCALE DRAWING	CHECKED/APPRVD	DWG. NO.	AA-00566-000 CUD	REV.	