

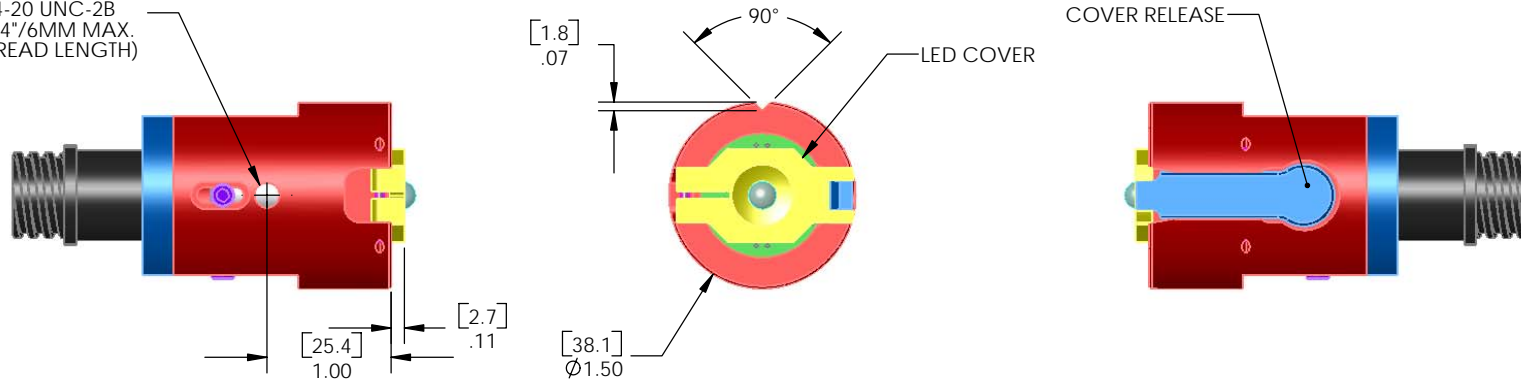

NOTE:

1/4-20 UNC-2B  
(1/4" / 6MM MAX.  
THREAD LENGTH)



UNLESS OTHERWISE SPECIFIED DIMENSIONS ARE IN INCHES TOLERANCES ARE: FRACTIONS    DECIMALS    ANGLES ±1/64        XX = ±0.01        ±30 XXX = ±0.005		THE INFORMATION CONTAINED IN THIS DRAWING IS THE SOLE PROPERTY OF Labsphere, INC. ANY REPRODUCTION IN PART OR IN WHOLE WITHOUT THE WRITTEN PERMISSION OF Labsphere, INC. IS PROHIBITED		 PO BOX 70 231 SHAKER STREET NORTH SUTTON, NH 03260	
CAD GENERATED DRAWING. DO NOT MANUALLY UPDATE		SOCKET, LUXEON K2			
MATERIAL SEE BOM		APPROVALS	DATE	SIZ B	SCALE 1:1
FINISH Labsphere Std.		RESP ENG R. MONTIMINY	4/26/2006		SHEET 1 OF 1
DO NOT SCALE DRAWING		CHECKED/APPV C. SHAFFER	4/26/2006	DWG. NO. AS-02683-000 CUD	REV.

NOTE:

1/4-20 UNC-2B  
(1/4" / 6MM MAX.  
THREAD LENGTH)

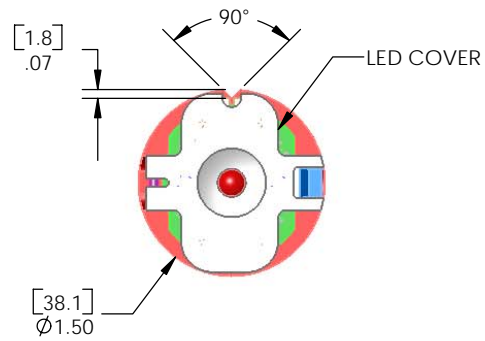
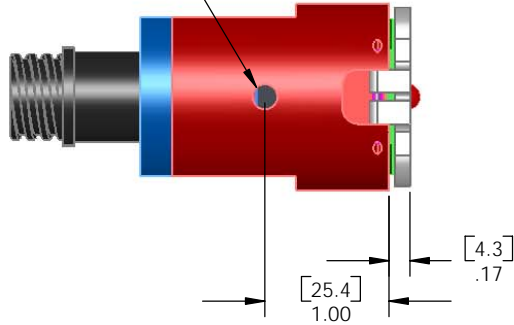

COVER RELEASE

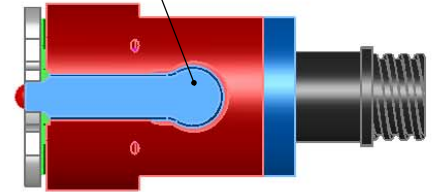

UNLESS OTHERWISE SPECIFIED DIMENSIONS ARE IN INCHES TOLERANCES ARE: FRACTIONS    DECIMALS    ANGLES ±1/64        XX = ±0.01        ±30 XXX = ±0.005		THE INFORMATION CONTAINED IN THIS DRAWING IS THE SOLE PROPERTY OF labsphere, INC. ANY REPRODUCTION IN PART OR IN WHOLE WITHOUT THE WRITTEN PERMISSION OF labsphere, INC. IS PROHIBITED		 PO BOX 70 231 SHAKER STREET NORTH SUTTON, NH 03260	
CAD GENERATED DRAWING. DO NOT MANUALLY UPDATE		SOCKET, LUXEON STAR			
MATERIAL SEE BOM		APPROVALS	DATE	SIZ	SCALE
FINISH Labsphere Std.		R. MONIMINY	4/26/2006	B	1:1
DO NOT SCALE DRAWING		CHECKED/APPV'D C. SHAFFER	4/26/2006	DWG. NO.	AS-02683-001 CUD
					SHEET 1 OF 1

NOTE:

1/4-20 UNC-2B  
(1/4"/6MM MAX.  
THREAD LENGTH)

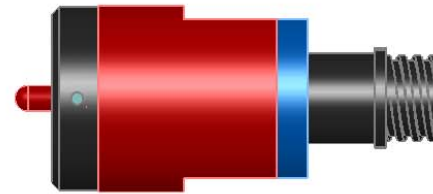
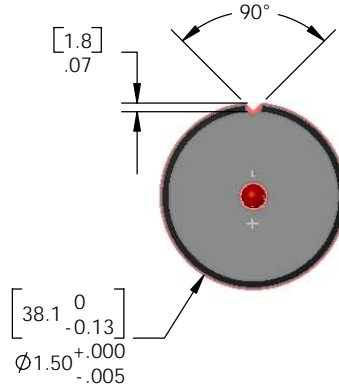
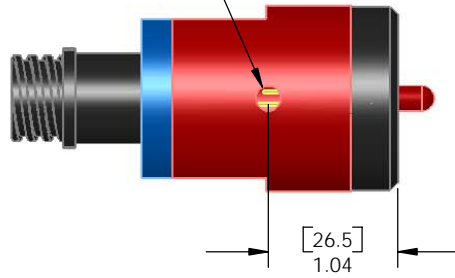

UNLESS OTHERWISE SPECIFIED  
DIMENSIONS ARE IN INCHES  
TOLERANCES ARE:  
FRACTIONS DECIMALS ANGLES  
±1/64 .001 ±30  
XXX = ±0.005

THE INFORMATION CONTAINED  
IN THIS DRAWING IS THE SOLE  
PROPERTY OF Ibsphere, INC.  
ANY REPRODUCTION IN PART OR  
IN WHOLE WITHOUT THE WRITTEN  
PERMISSION OF Ibsphere, INC.  
IS PROHIBITED



PO BOX 70  
231 SHAKER STREET  
NORTH SUTTON, NH  
03260

CAD GENERATED DRAWING  
DO NOT MANUALLY UPDATE

SOCKET, T 1-3/4

MATERIAL  
SEE BOM

APPROVALS	DATE	SIZ	SCALE	SHEET 1 OF 1
RESP ENG R.MONTIMINY	8/28/2006	B	1:1	

DO NOT SCALE DRAWING

CHECKED/APPRVD	8/28/2006	DWG. NO.	AS-02683-002 CUD	REV.
----------------	-----------	----------	------------------	------

DWG. NO.	AS-02683-002 CUD	REV.	
----------	------------------	------	--

NOTE:

1/4-20 UNC-2B  
(1/4" / 6MM MAX.  
THREAD LENGTH)

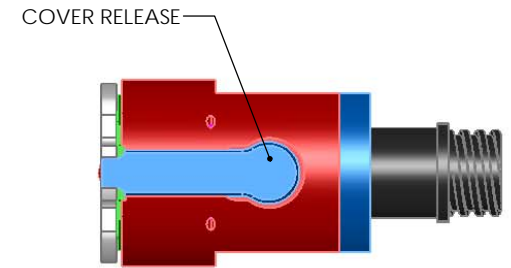
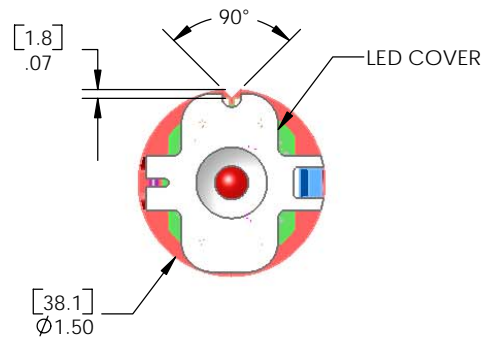
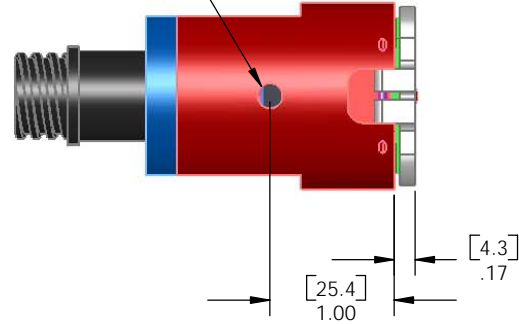

UNLESS OTHERWISE SPECIFIED DIMENSIONS ARE IN INCHES TOLERANCES ARE: FRACTIONS DECIMALS ANGLES ±1/64 .001 ±30		THE INFORMATION CONTAINED IN THIS DRAWING IS THE SOLE PROPERTY OF labsphere, INC. ANY REPRODUCTION IN PART OR IN WHOLE WITHOUT THE WRITTEN PERMISSION OF labsphere, INC. IS PROHIBITED		 PO BOX 70 231 SHAKER STREET NORTH SUTTON, NH 03260	
CAD GENERATED DRAWING. DO NOT MANUALLY UPDATE		SOCKET, OSRAM OSTAR			
MATERIAL SEE BOM		APPROVALS	DATE	SIZ B	SCALE 1:1
FINISH Labsphere Std.		RESP ENG R.MONTIMINY	8/28/2006		SHEET 1 OF 1
DO NOT SCALE DRAWING		CHECKED/APPRVD	8/28/2006	DWG. NO.	AS-02683-003 CUD <sup>REV</sup>

NOTE:

1/4-20 UNC-2B  
(1/4" / 6MM MAX.  
THREAD LENGTH)

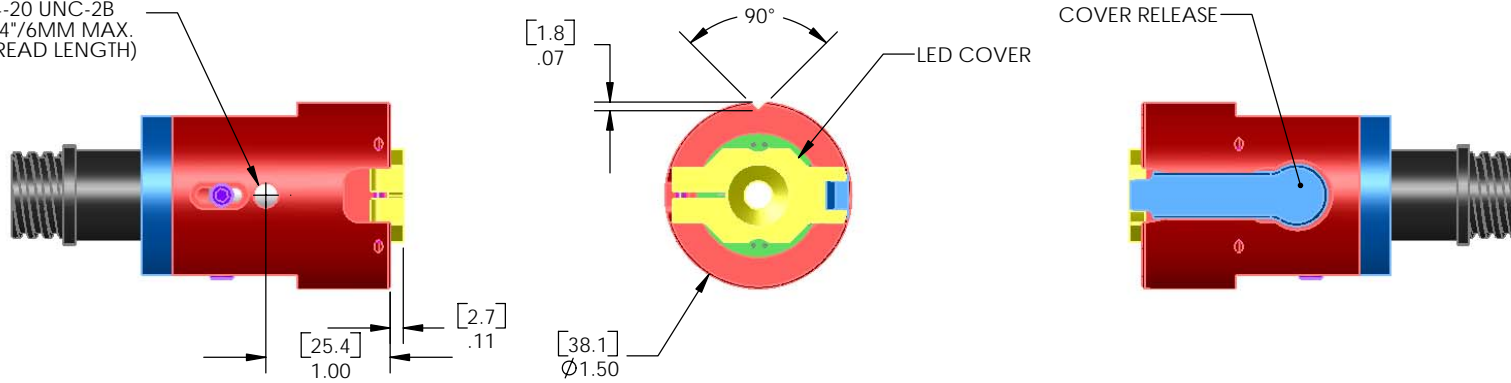

UNLESS OTHERWISE SPECIFIED DIMENSIONS ARE IN INCHES TOLERANCES ARE: FRACTIONS    DECIMALS    ANGLES ±1/64        XX = ±0.01        ±30 XXX = ±0.005		THE INFORMATION CONTAINED IN THIS DRAWING IS THE SOLE PROPERTY OF Labsphere, INC. ANY REPRODUCTION IN PART OR IN WHOLE WITHOUT THE WRITTEN PERMISSION OF Labsphere, INC. IS PROHIBITED		 PO BOX 70 231 SHAKER STREET NORTH SUTTON, NH 03260	
CAD GENERATED DRAWING. DO NOT MANUALLY UPDATE		SOCKET, OSRAM GOLDEN DRAGON			
MATERIAL SEE BOM		APPROVALS	DATE	SIZ B	SCALE 1:1
FINISH Labsphere Std.		RESP ENG R.MONTIMINY	8/28/2006	SHEET 1 OF 1	
DO NOT SCALE DRAWING		CHECKED/APPRVD	8/28/2006	DWG. NO. AS-02683-004 CUD	